

SIERRA POINT PROJECT
BRISBANE, CA.



SITE PLAN

REVISED 01/04/06 REVISED 09/21/07
 REVISED 11/27/06 REVISED 10/29/07
 REVISED 06/25/07 REVISED 12/24/07
 REVISED 08/10/07 REVISED 01/15/08

A-1



Project Number: 9619.01

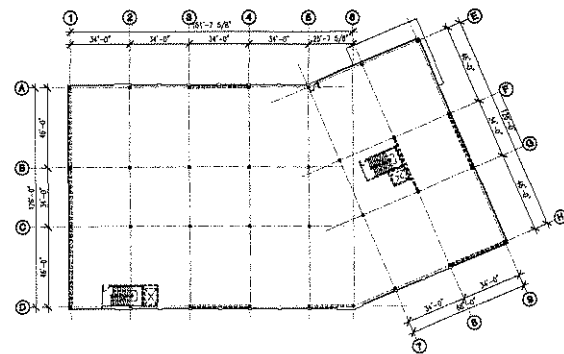

2 SECOND & THIRD FLOOR PLAN

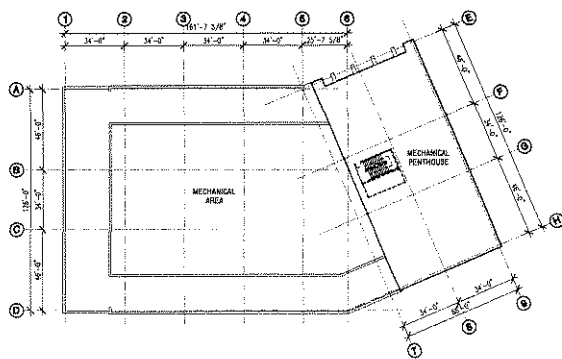

3 ROOF PLAN

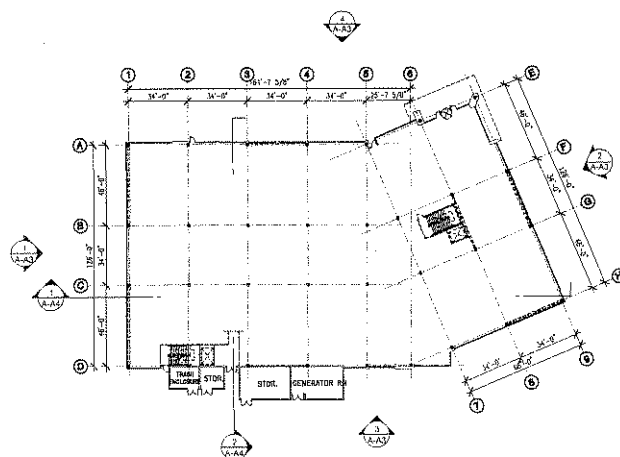

1 FIRST FLOOR PLAN

SCALE: 1/32" = 1'-0"
0 16 32 64

SIERRA POINT PROJECT
BRISBANE, CA.



BUILDING A, PLANS
08/23/06

A-A2



Project Number: 9619.01

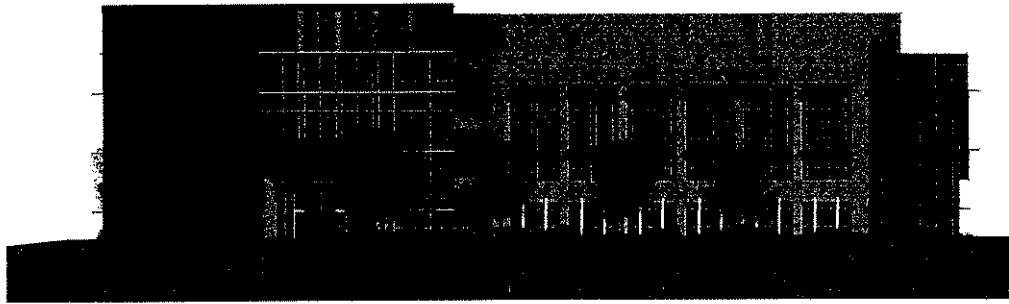

4 NORTH ELEVATION

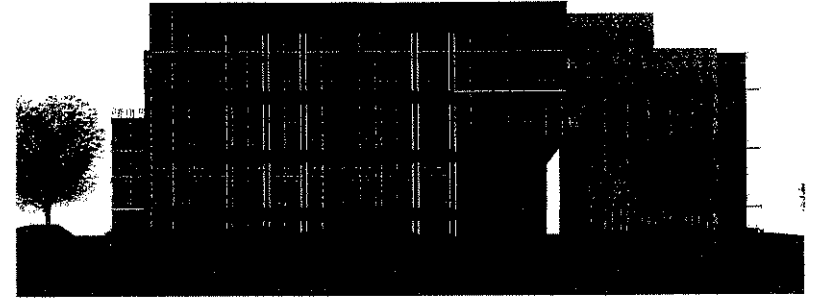

2 EAST ELEVATION

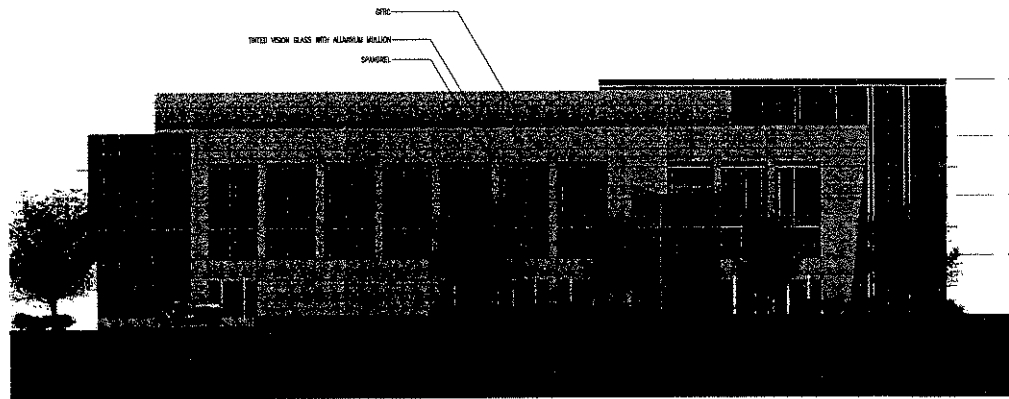

3 SOUTH ELEVATION

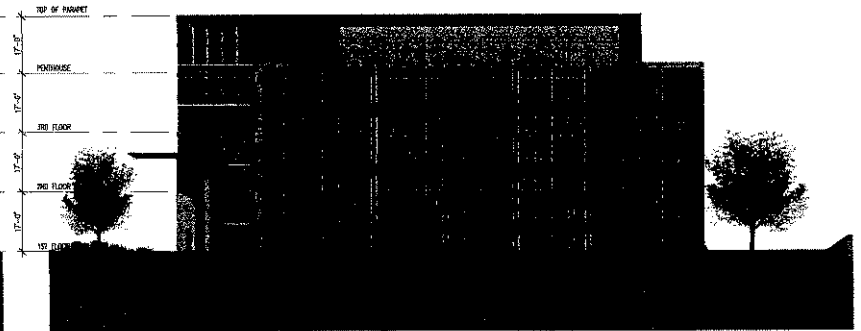

1 WEST ELEVATION

SCALE: 1/16" = 1'-0"
0 6 18 32'

SIERRA POINT PROJECT
BRISBANE, CA.



BUILDING A, ELEVATIONS
08/23/05

A-A3 DES
Project Number: 9619.01

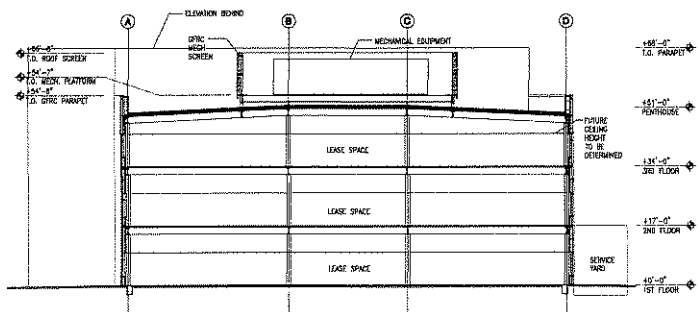

2 BUILDING CROSS SECTION

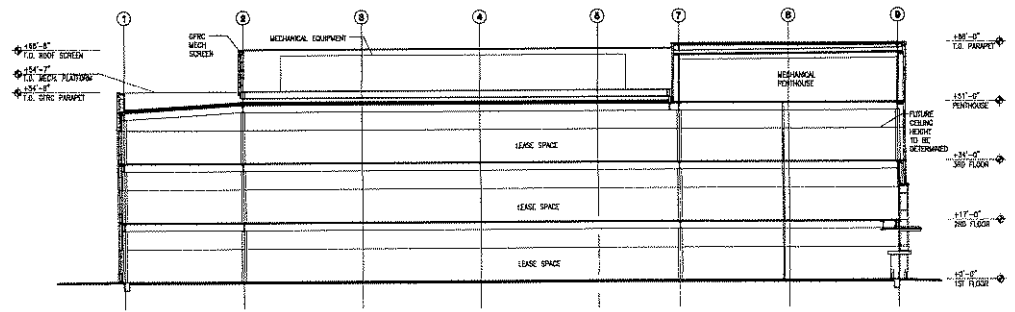

1 BUILDING LONGITUDINAL SECTION

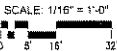

SIERRA POINT PROJECT
 BRISBANE, CA.



BUILDING A, SECTIONS
 08/23/05

A-A4



Project Number: 9619.01

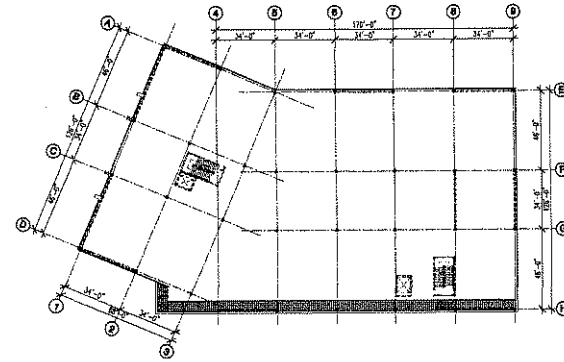

2 4TH FLOOR PLAN

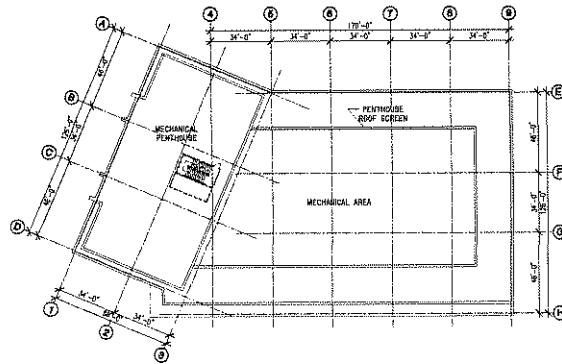

3 ROOF PLAN

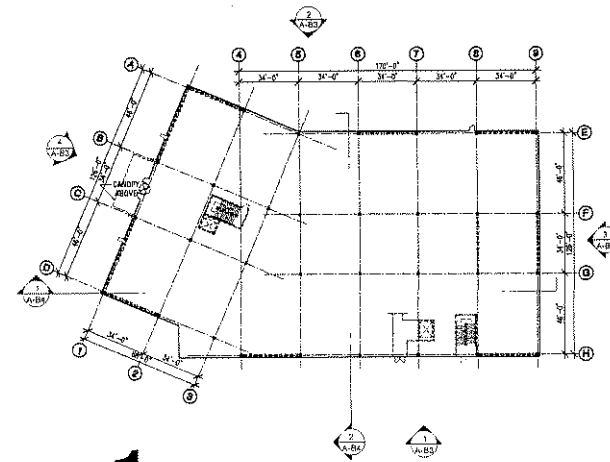

1 1ST, 2ND & 3RD FLOOR PLAN

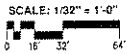

SIERRA POINT PROJECT
BRISBANE, CA



BUILDING B, PLANS
08/23/05

A-B2



Project Number 9619.01

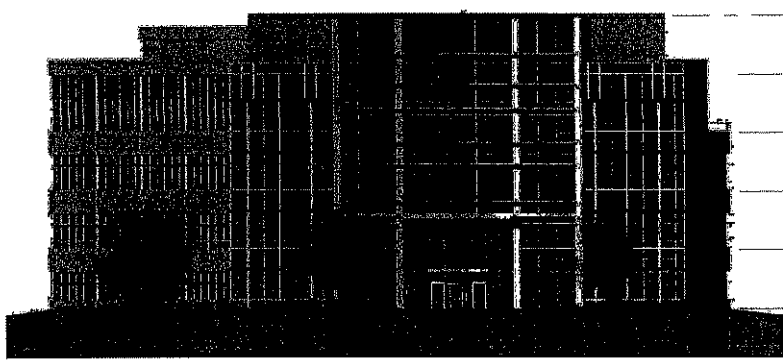

4 NORTH ELEVATION

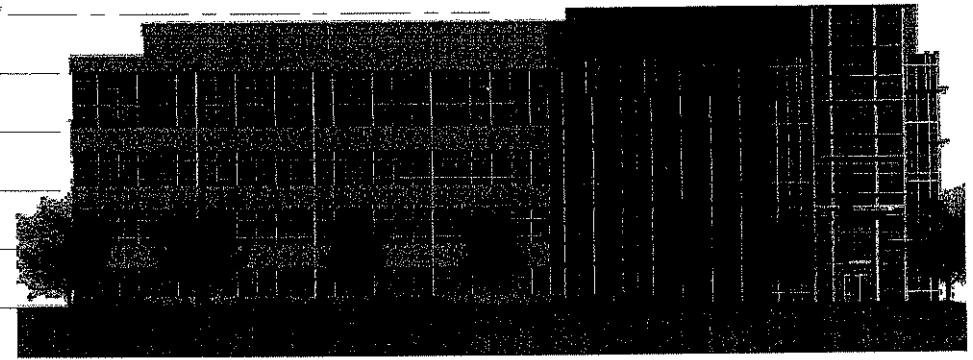

2 EAST ELEVATION

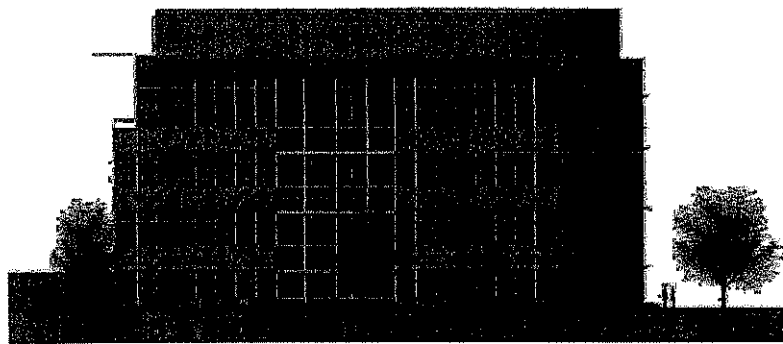

3 SOUTH ELEVATION

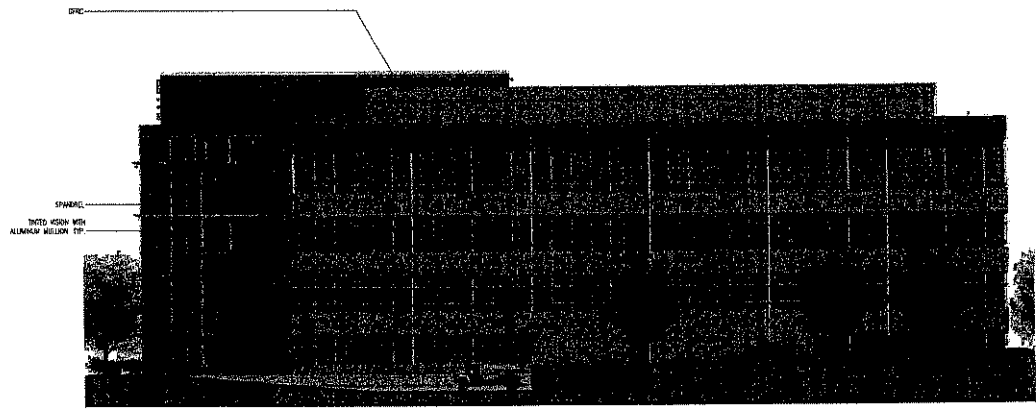

1 WEST ELEVATION

SCALE: 1/16" = 1'-0"
0 8' 16' 32'

SIERRA POINT PROJECT
BRISBANE, CA



BUILDING B, ELEVATIONS
08/23/06

A-B3



Project Number: 9619 01

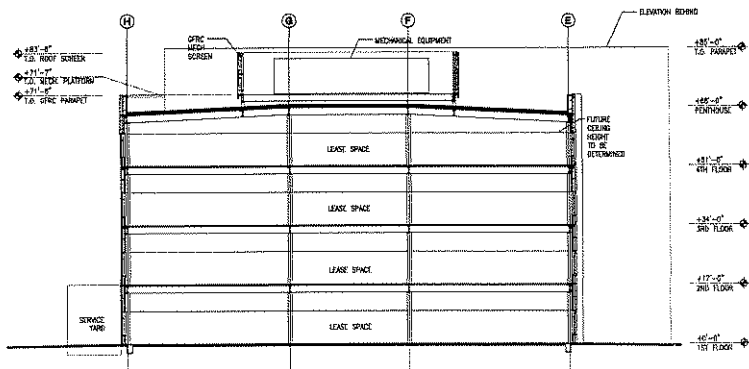

2 BUILDING CROSS SECTION

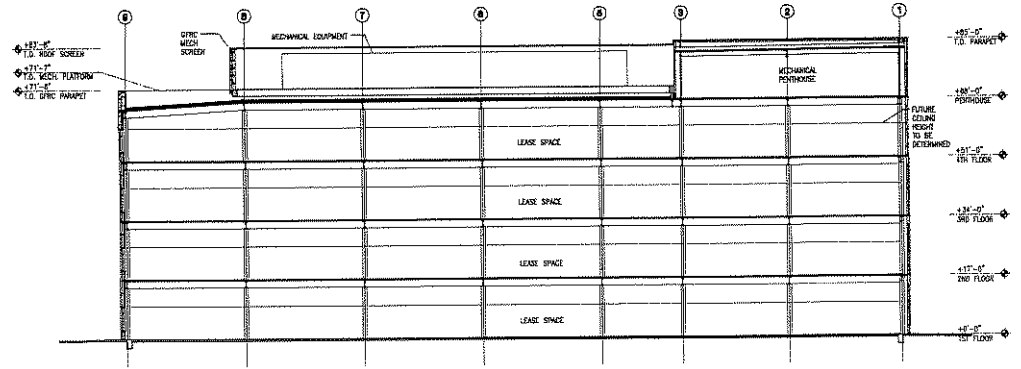

1 BUILDING LONGITUDINAL SECTION

SCALE: 1/16" = 1'-0"
 0 8 16 32

SIERRA POINT PROJECT
 BRISBANE, CA



BUILDING B, SECTIONS
 08/23/05

A-B4 **DES**
 Project Number 9619 01

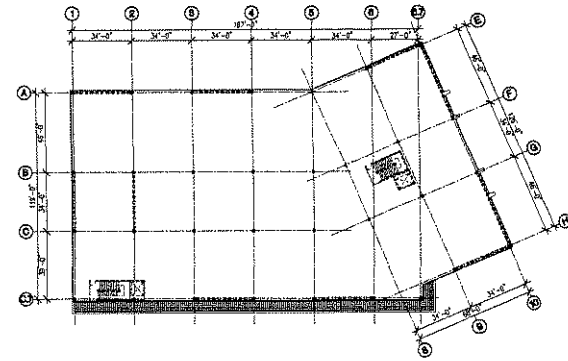

2 FOURTH FLOOR PLAN

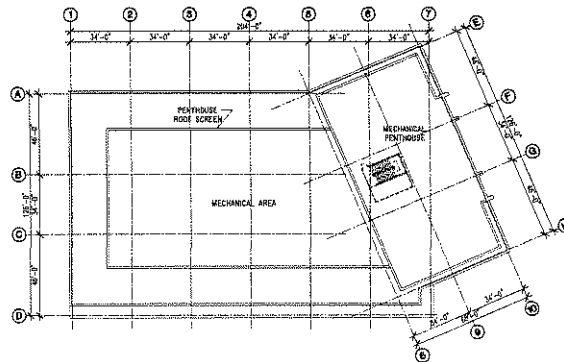

3 ROOF PLAN

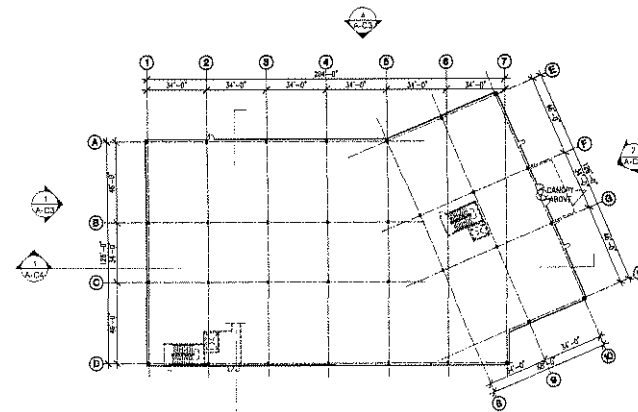

1 FIRST, SECOND AND THIRD FLOOR PLAN

SCALE: 1/32" = 1'-0"
0 8' 16' 32'

SIERRA POINT PROJECT
BRISBANE, CA



BUILDING C, PLANS

08/23/05
REVISED 06/25/07

A-C2



Project Number: 9619.01

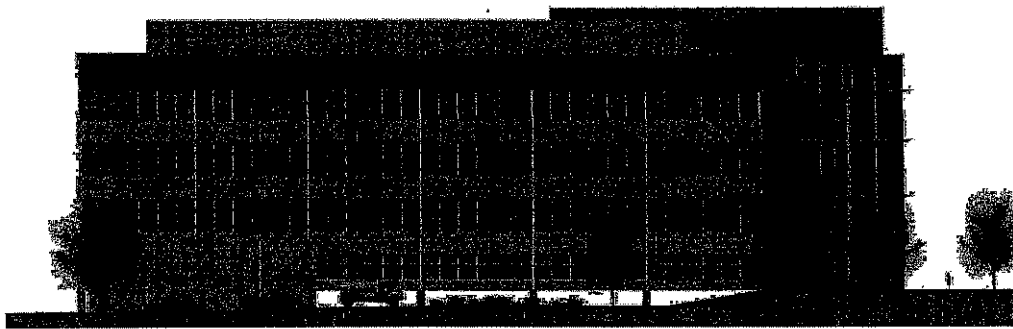

4 NORTH ELEVATION

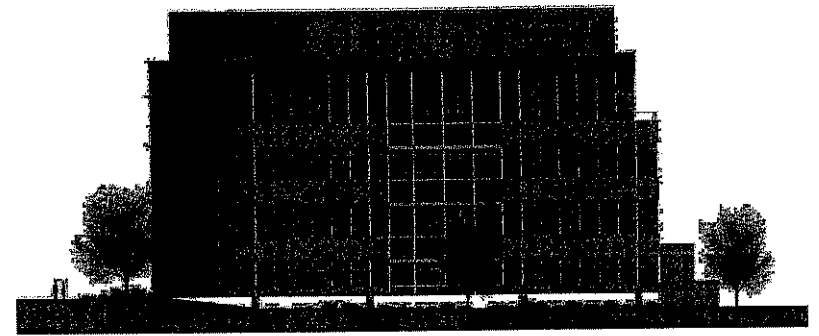

2 EAST ELEVATION

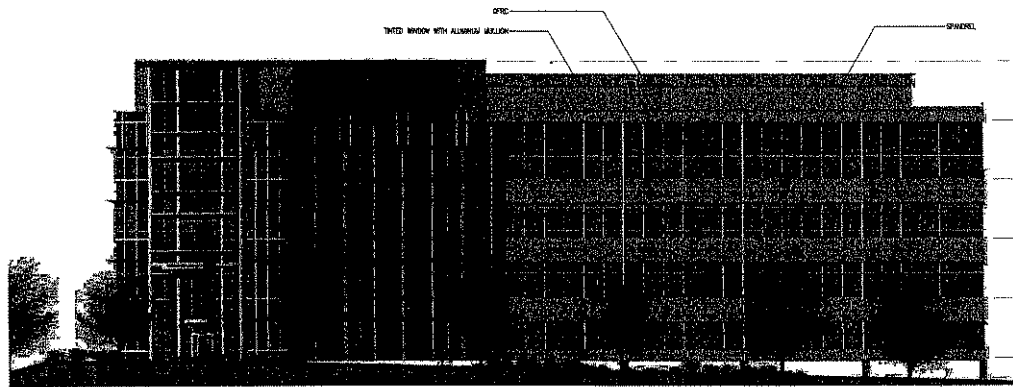

3 SOUTH ELEVATION

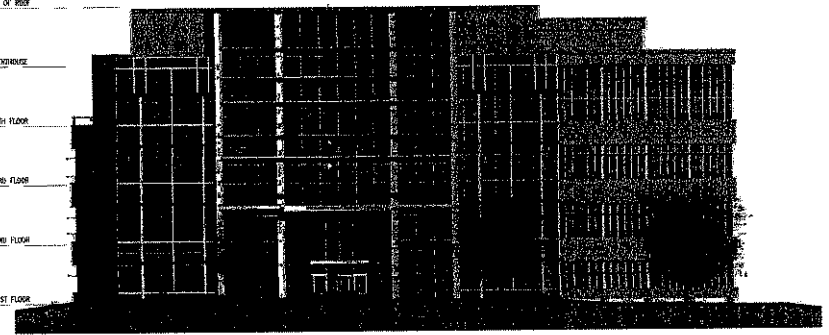

1 WEST ELEVATION

SCALE 1/16" = 1'-0"
0 8' 16' 32'

SIERRA POINT PROJECT
BRISBANE, CA



BUILDING C, ELEVATIONS
08/23/05

A-C3
DES
Project Number 9619 01

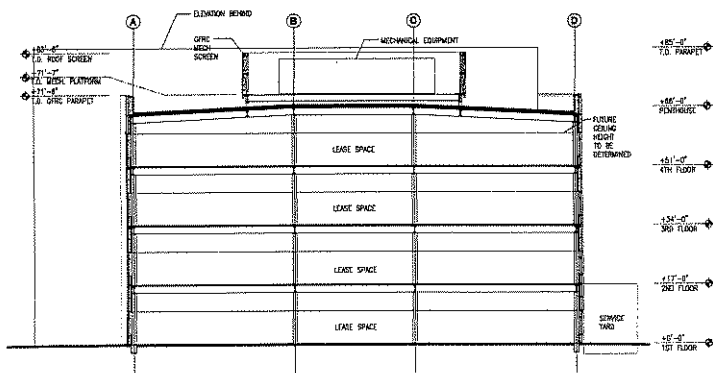

2 BUILDING CROSS SECTION

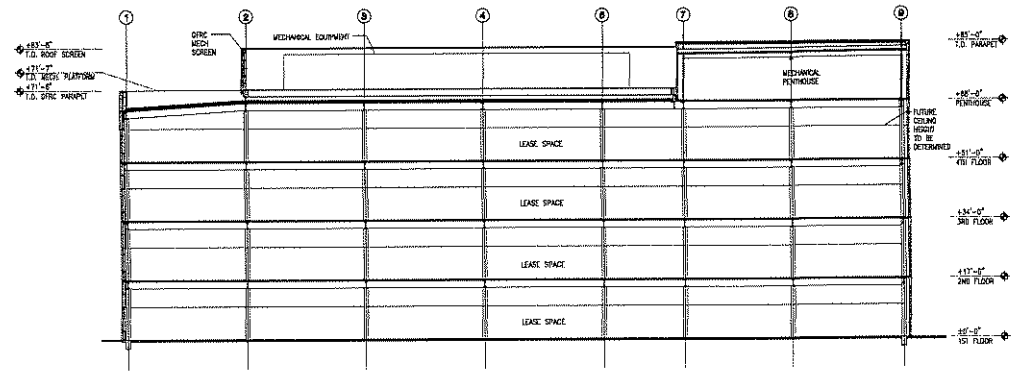

1 BUILDING LONGITUDINAL SECTION

SCALE 1/16" = 1'-0"
0 8' 16' 32'

SIERRA POINT PROJECT
BRISBANE, CA.



BUILDING C, SECTIONS
08/23/05
REVISED 06/25/07

A-C4 DES
Project Number 9618.01

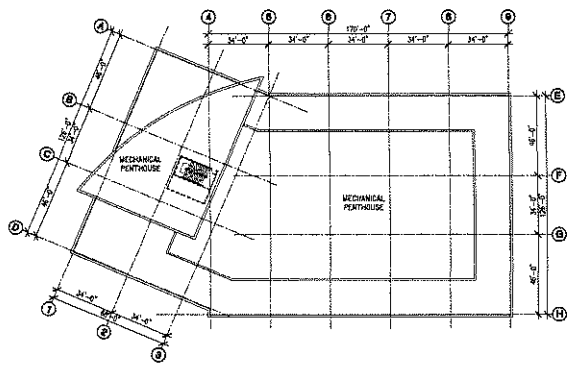

4 ROOF PLAN

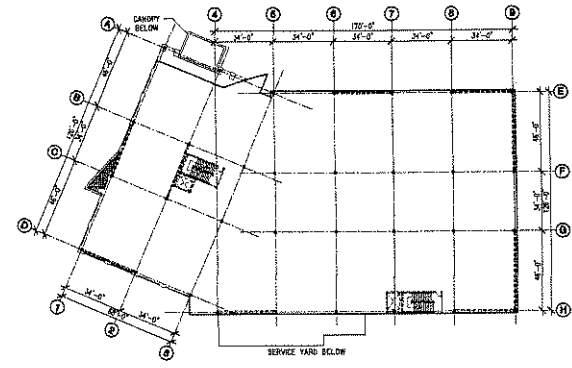

2 SECOND FLOOR PLAN

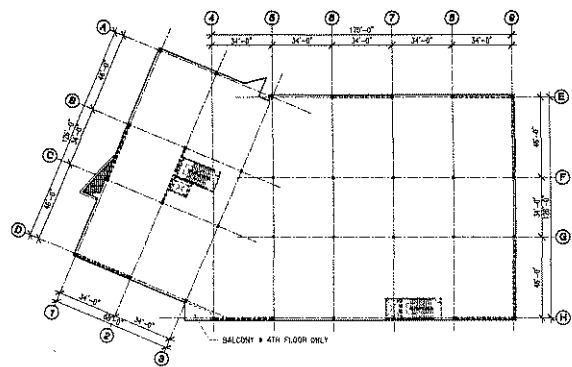

3 THIRD & FOURTH FLOOR PLAN

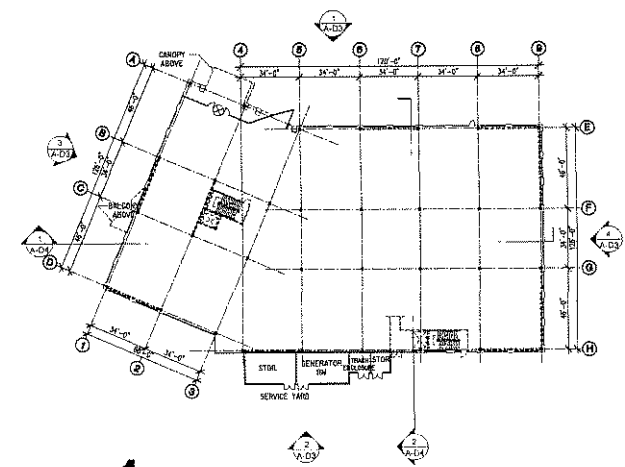

1 FIRST FLOOR PLAN

SCALE: 1/32" = 1'-0"
0 16 32 64

SIERRA POINT PROJECT
BRISBANE, CA.



BUILDING D, PLANS
08/23/05

A-D2 **DES**
Project Number: 9519.01

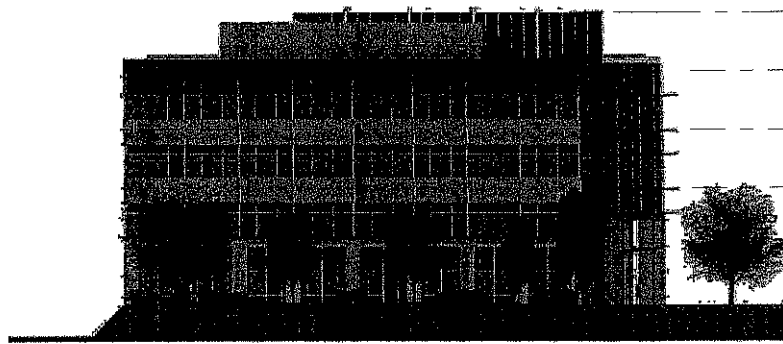

4 NORTH ELEVATION

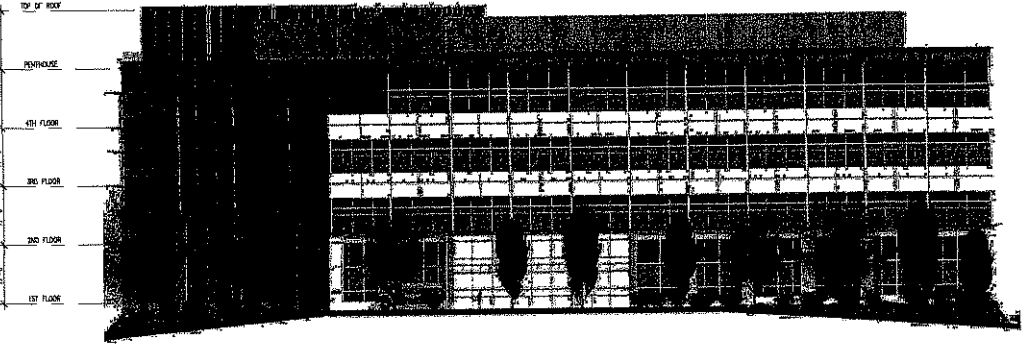

2 EAST ELEVATION

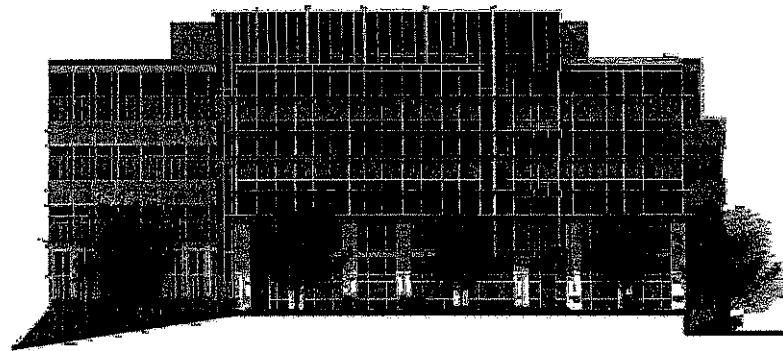

3 SOUTH ELEVATION

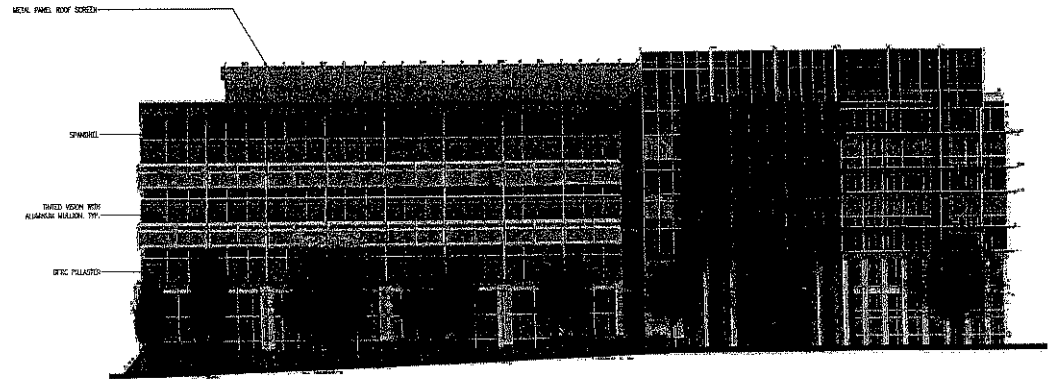

1 WEST ELEVATION

SCALE: 1/16" = 1'-0"
0 8' 16' 32'

SIERRA POINT PROJECT
BRISBANE, CA



BUILDING D, ELEVATIONS
08/23/05

A-D3
DES
Project Number 9619.01

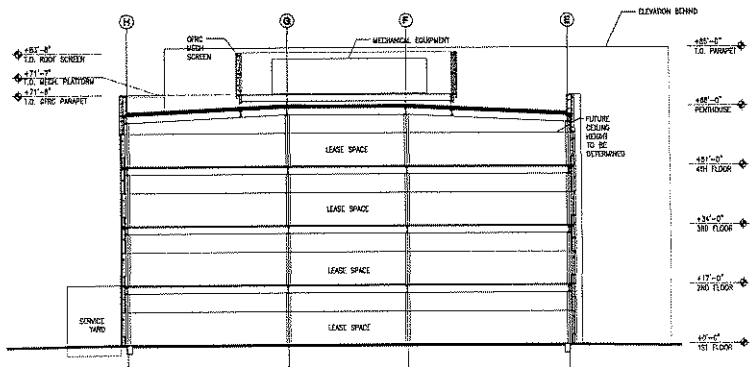

2 BUILDING CROSS SECTION

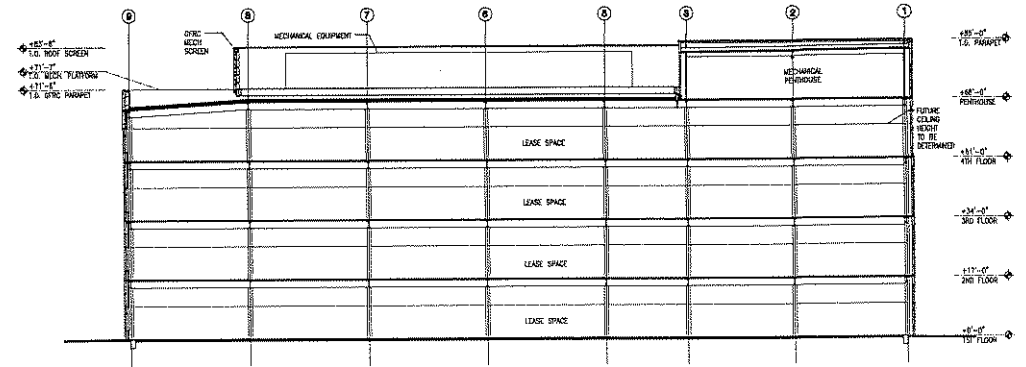

1 BUILDING LONGITUDINAL SECTION

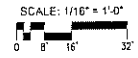

SIERRA POINT PROJECT
BRISBANE, CA



BUILDING D, SECTIONS
08/23/05

A-D4 **DES**
DESIGN ENGINEERS
Project Number: 9619 01

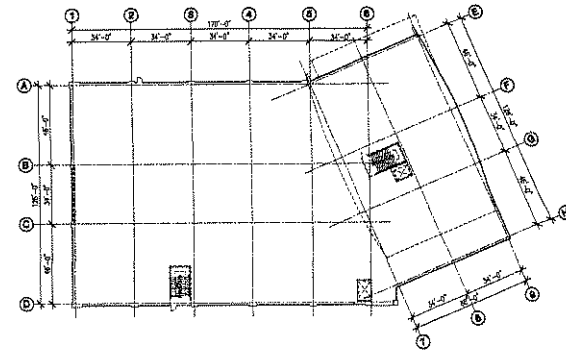

2 SECOND & THIRD FLOOR PLAN

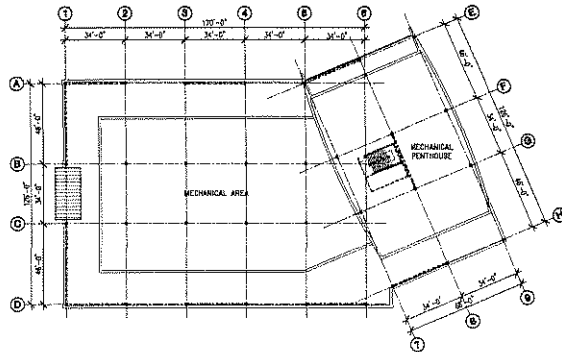

3 ROOF PLAN

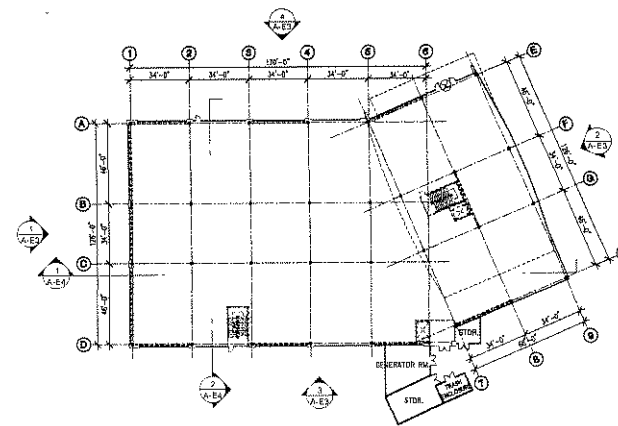

1 FIRST FLOOR PLAN



SCALE: 1/32" = 1'-0"
0 16 32 64

SIERRA POINT PROJECT
BRISBANE, CA



BUILDING E, PLANS
08/23/05

A-E2



Project Number: 9619 D1

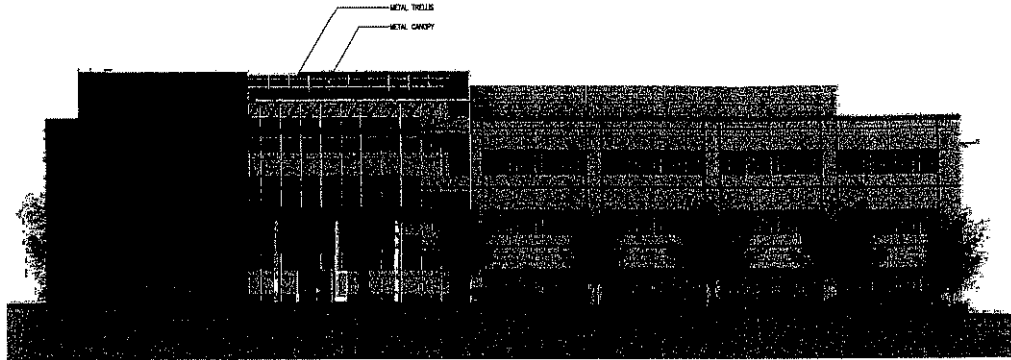

4 NORTH ELEVATION

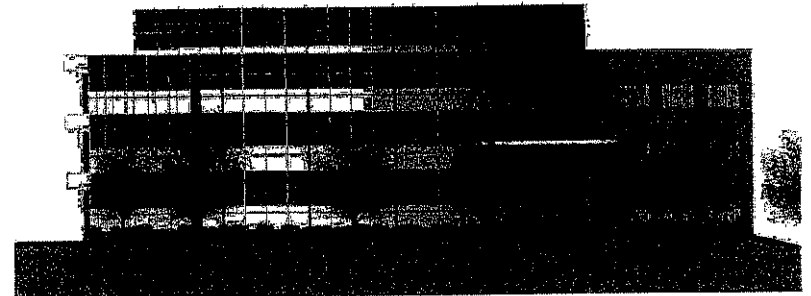

2 EAST ELEVATION

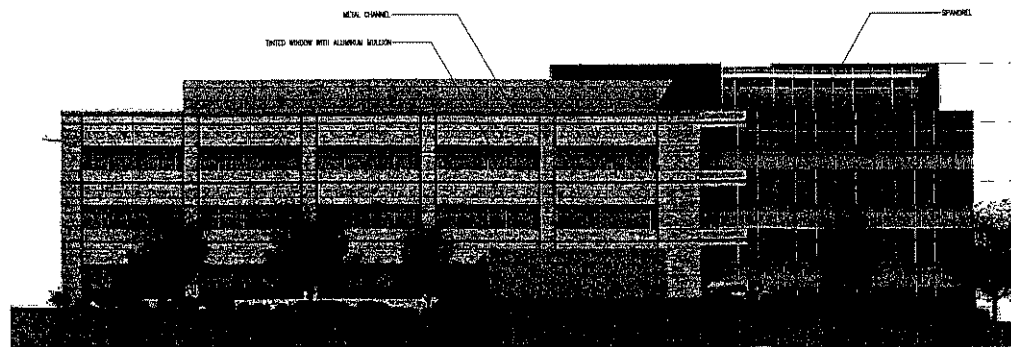

3 SOUTH ELEVATION

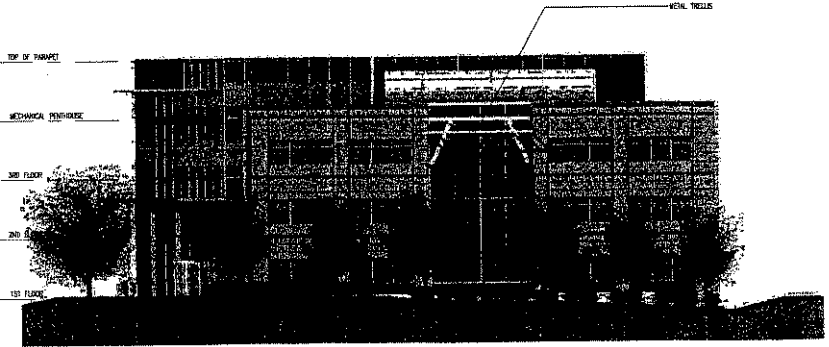

1 WEST ELEVATION

SCALE: 1/16" = 1'-0"
0 8 16 32

SIERRA POINT PROJECT
BRISBANE, CA



BUILDING E, ELEVATIONS
08/23/05

A-E3



Project Number: 9619.01

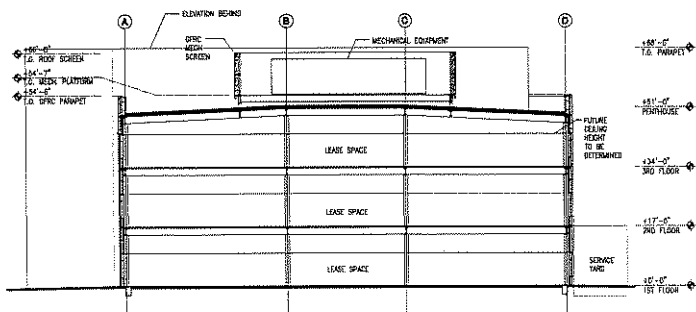

2 BUILDING CROSS SECTION

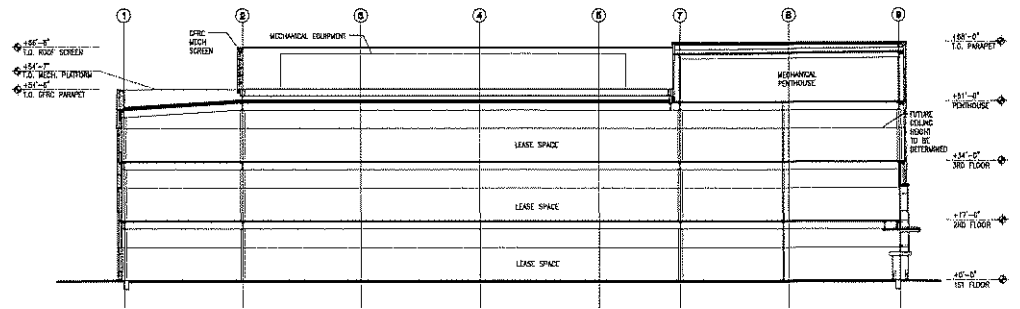

1 BUILDING LONGITUDINAL SECTION

SCALE: 1/16" = 1'-0"
 0 6' 12' 24'

SIERRA POINT PROJECT
 BRISBANE, CA



BUILDING E, SECTIONS
 08/23/06

A-E4



Project Number 9615 01

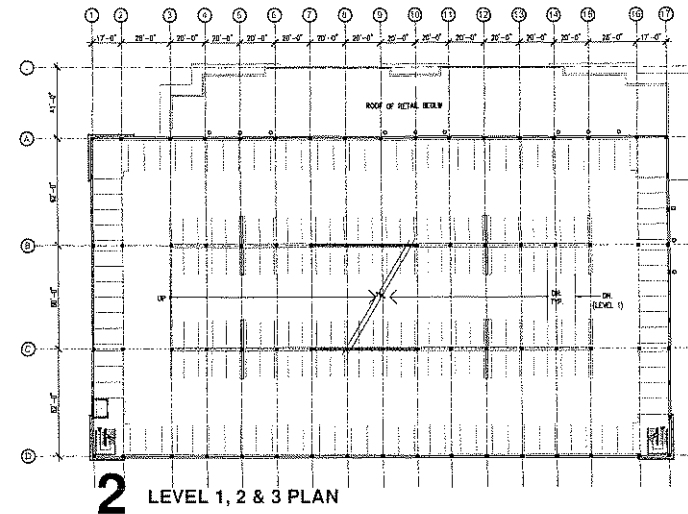

NUMBER OF PARKING @ GARAGE

LEVEL 4:	STANDARD SIZE (9'x16'):	87 CARS
	COMPACT SIZE (8'x6'):	128 CARS
LEVEL 3:	STANDARD SIZE (9'x16'):	91 CARS
	COMPACT SIZE (8'x16'):	116 CARS
LEVEL 2:	STANDARD SIZE (9'x16'):	91 CARS
	COMPACT SIZE (8'x16'):	116 CARS
LEVEL 1:	STANDARD SIZE (9'x16'):	91 CARS
	COMPACT SIZE (8'x16'):	116 CARS
SURFACE LEVEL:	STANDARD SIZE (9'x16'):	67 CARS
	COMPACT SIZE (8'x16'):	98 CARS
PARKING GARAGE TOTAL:		
	STANDARD SIZE (9'x16'):	427 CARS
	COMPACT SIZE (8'x16'):	534 CARS
		961 CARS

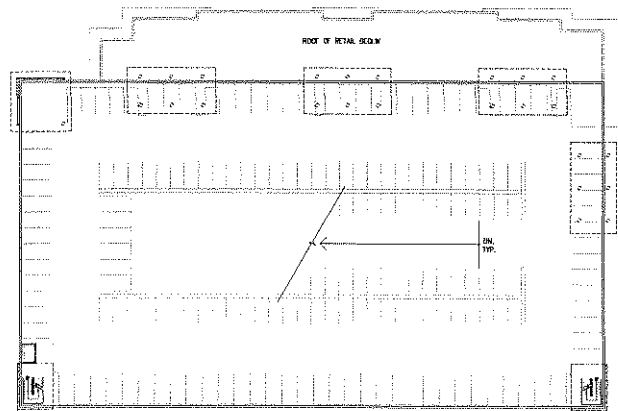

3 LEVEL 4 PLAN

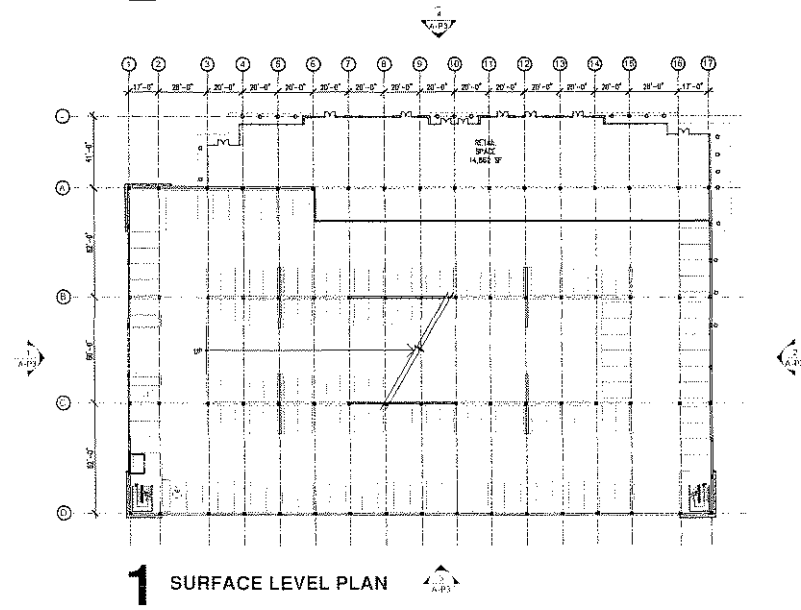

1 SURFACE LEVEL PLAN

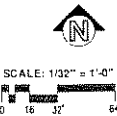

SIERRA POINT PROJECT
BRISBANE, CA.



PARKING GARAGE PLANS

REVISED 01/04/06 REVISED 08/21/07
REVISED 06/25/07 REVISED 10/29/07
REVISED 08/10/07 REVISED 12/24/07

A-P2



Project Number 9619 01

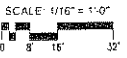
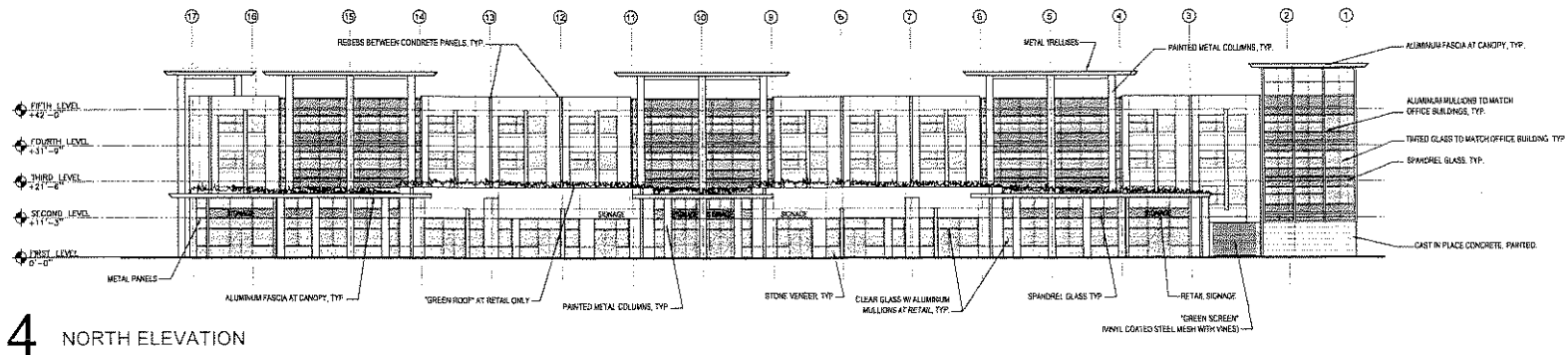
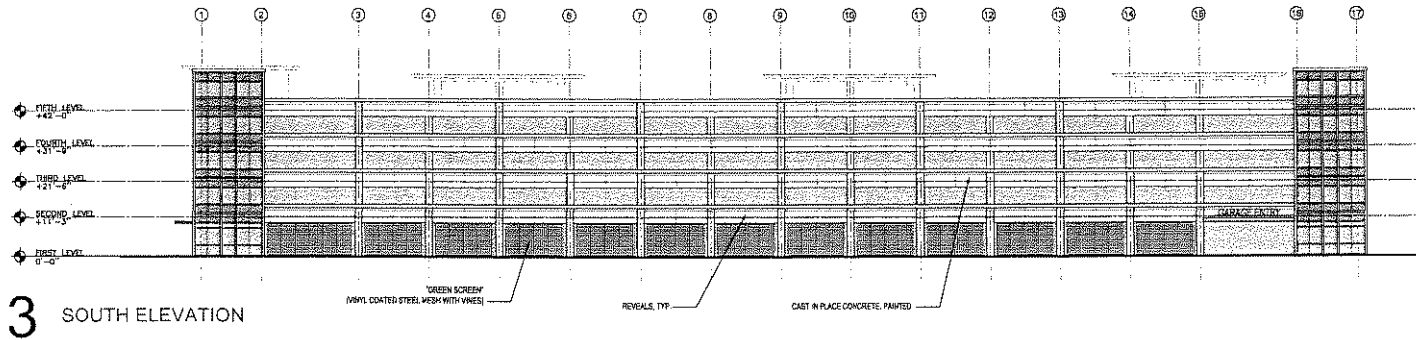
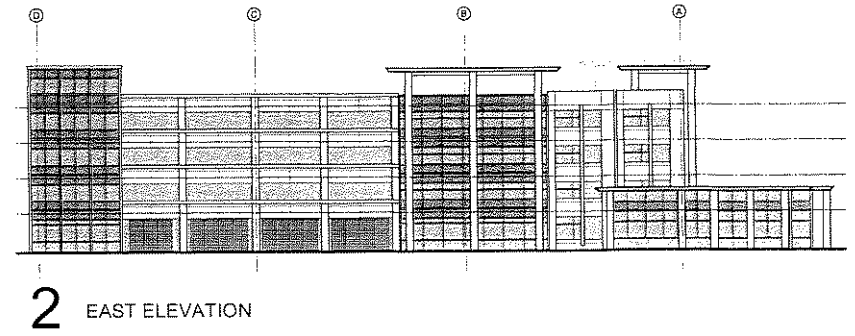
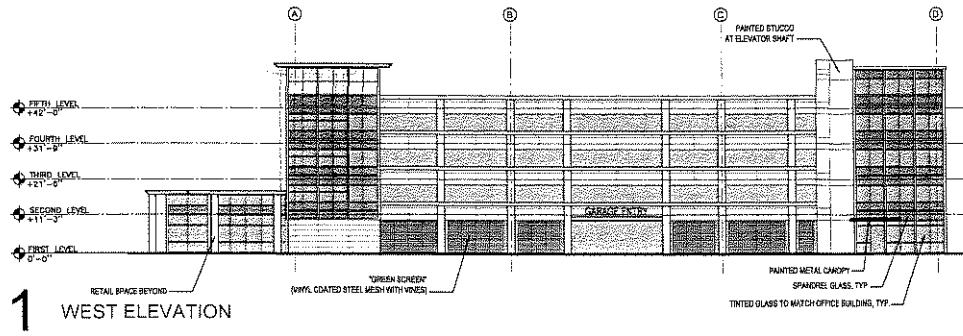

SIERRA POINT PROJECT
BRISBANE, CA.



PARKING GARAGE ELEVATIONS

REVISED 01/04/06
REVISED 11/27/06
REVISED 06/10/07
REVISED 09/01/07
REVISED 10/29/07
REVISED 12/24/07
REVISED 01/15/08

A-P3



Project Number: 9610.01